

# DC Axial Fans

## YD81X12L(M)(H) YD81X24L(M)(H)

### Features

Size: 80×80×15mm(3.15×3.15×0.57in)

Frame/Impeller: Reinforced Plastic UL94V-0

Bearings: Ball Bearing&Sleeve Bearing

Life Expectancy:50,000 Hours at 20°C-Ball

30,000 Hours at 20°C-Sleeve

Approvals: UL CUL TUV CE RoHS

Weight: 45g

  E318377 CE TUV AE50078978

▪ RoHS Compliant

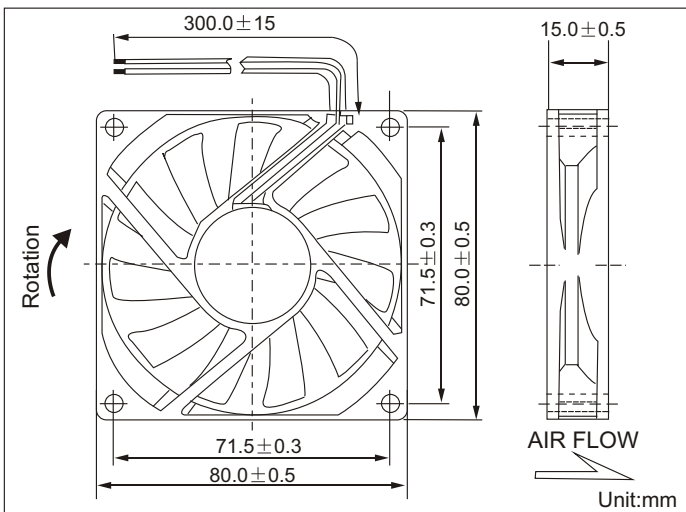

### Air Flow vs Air Pressure

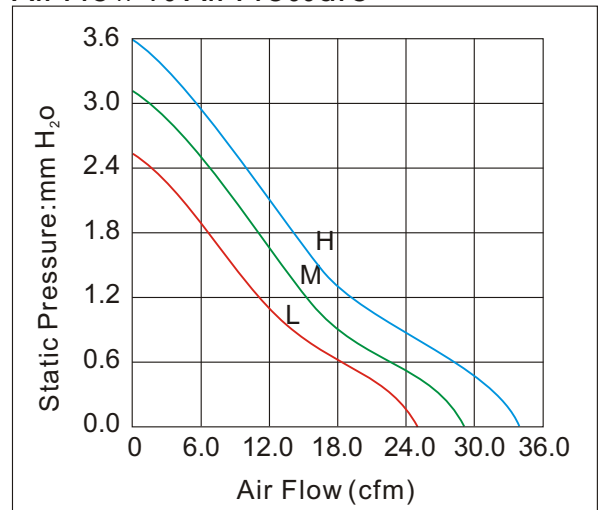

### Performance

Model	Bearing System X			Rated Voltage (V)	Current (A)	Input Power (W)	Nominal Speed (R.P.M)	Air Flow (CFM)	Air Pressure (mm-H <sub>2</sub> O)	Noise (dBA)
	S	B	D							
YD81X12L	✓	✓	✓	12	0.10	1.20	2500	24.30	2.51	25
YD81X12M	✓	✓	✓	12	0.15	1.80	3000	28.66	3.02	30
YD81X12H	✓	✓	✓	12	0.22	2.64	3500	33.12	3.53	32
YD81X24L	✓	✓	✓	24	0.10	2.40	2500	24.30	2.51	25
YD81X24M	✓	✓	✓	24	0.12	2.88	3000	28.66	3.02	30
YD81X24H	✓	✓	✓	24	0.15	3.60	3500	33.12	3.53	32