

# DC Axial Fans

## YD71X12L(M)(H) YD71X24L(M)(H)

### Features

Size: 70×70×15mm(2.76×2.76×0.57in)

Frame/Impeller: Reinforced Plastic UL94V-0



Bearings: Ball Bearing&Sleeve Bearing

Life Expectancy:50,000 Hours at 20°C-Ball

30,000 Hours at 20°C-Sleeve

Approvals: UL CUL TUV CE RoHS

Weight: 45g

  E318377 CE TUV AE50078978

▪ RoHS Compliant

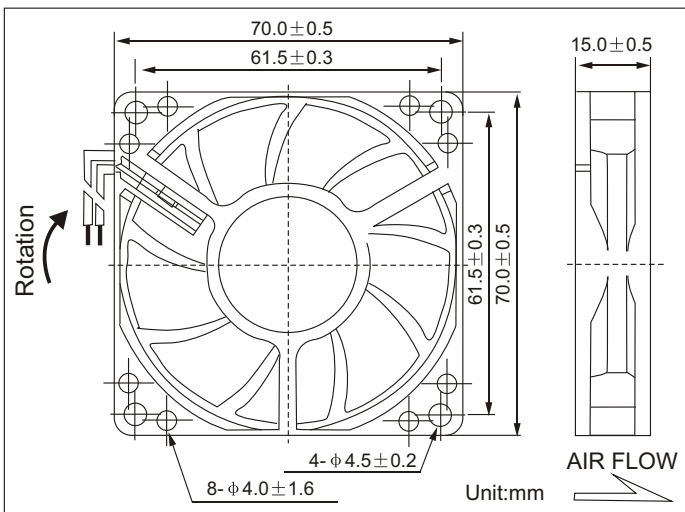

### Air Flow vs Air Pressure

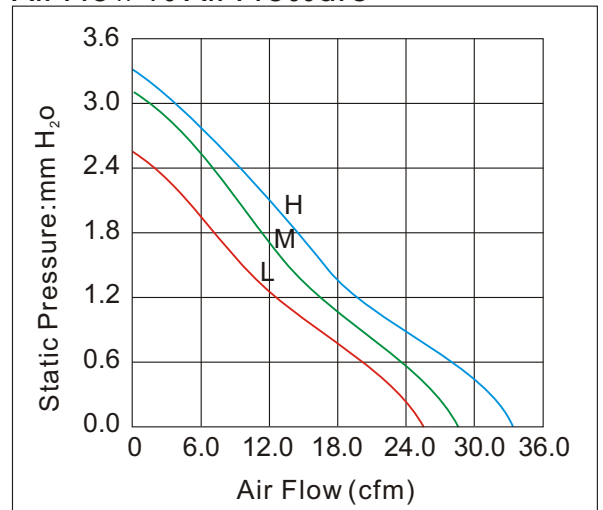

### Performance

Model	Bearing System X			Rated Voltage (V)	Current (A)	Input Power (W)	Nominal Speed (R.P.M)	Air Flow (CFM)	Air Pressure (mm-H <sub>2</sub> O)	Noise (dBA)
	S	B	D							
YD71X12L	✓	✓	✓	12	0.15	1.80	3000	24.80	2.50	30
YD71X12M	✓	✓	✓	12	0.18	2.16	3500	28.85	3.02	35
YD71X12H	✓	✓	✓	12	0.22	2.64	4000	33.52	3.33	40
YD71X24L	✓	✓	✓	24	0.08	1.92	3000	24.80	2.50	30
YD71X24M	✓	✓	✓	24	0.15	3.60	3500	28.85	3.02	35
YD71X24H	✓	✓	✓	24	0.20	4.80	4000	33.52	3.33	40