

DC Axial Fans



YD60X12L(M)(H) YD60X24L(M)(H)

Features

Size: 60×60×25mm(2.36×2.36×1.0in)

Frame/Impeller: Reinforced Plastic UL94V-0

Bearings: Ball Bearing&Sleeve Bearing

Life Expectancy:50,000 Hours at 20°C-Ball
30,000 Hours at 20°C-Sleeve

Approvals: UL CUL TUV CE RoHS

Weight: 55g

  E318377 CE TUV AE50078978

▪ RoHS Compliant

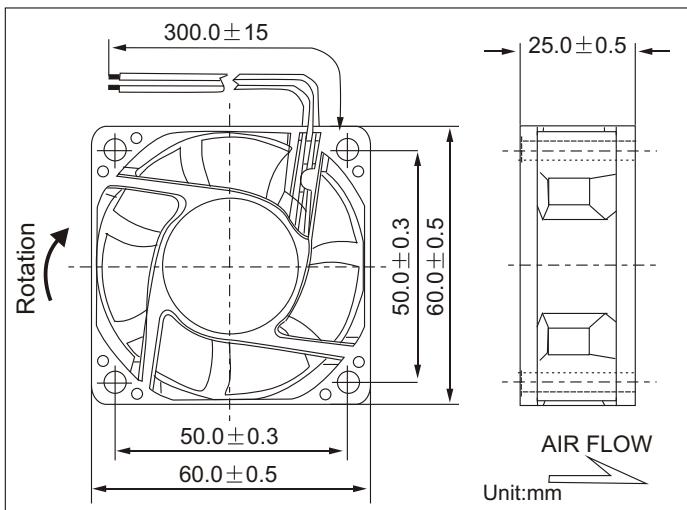

Air Flow vs Air Pressure

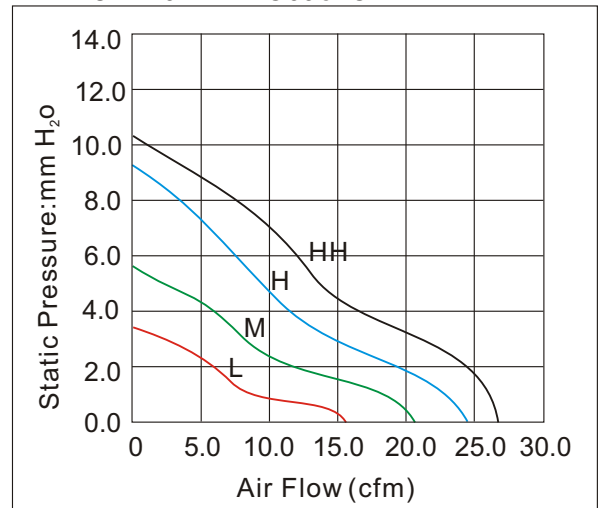

Performance

Model	Bearing System X			Rated Voltage (V)	Current (A)	Input Power (W)	Nominal Speed (R.P.M)	Air Flow (CFM)	Air Pressure (mm-H ₂ O)	Noise (dBA)
	S	B	D							
YD60X12L	✓	✓	✓	12	0.08	0.96	3500	15.80	3.51	27
YD60X12M	✓	✓	✓	12	0.15	1.80	4500	20.15	5.92	33
YD60X12H	✓	✓	✓	12	0.25	3.00	5500	24.71	8.80	38
YD60X12HH	✓	✓	✓	12	0.30	3.60	6000	27.05	10.12	41
YD60X24L	✓	✓	✓	24	0.08	1.92	3500	15.80	3.51	27
YD60X24M	✓	✓	✓	24	0.12	2.88	4500	20.15	5.92	33
YD60X24H	✓	✓	✓	24	0.15	3.60	5500	24.71	8.80	38
YD60X24HH	✓	✓	✓	24	0.18	4.43	6000	27.05	10.12	41