

DC Axial Fans



YD50X05L(M)(H) YD50X12L(M)(H) YD50X24L(M)(H)

Features

Size: 50×50×10mm(1.97×1.97×0.39in)

Frame/Impeller: Reinforced Plastic UL94V-0

Bearings: Ball Bearing&Sleeve Bearing

Life Expectancy:50,000 Hours at 20°C-Ball
30,000 Hours at 20°C-Sleeve

Approvals: UL CUL TUV CE RoHS

Weight: 18g

  E318377 CE TUV AE50078978

▪ RoHS Compliant

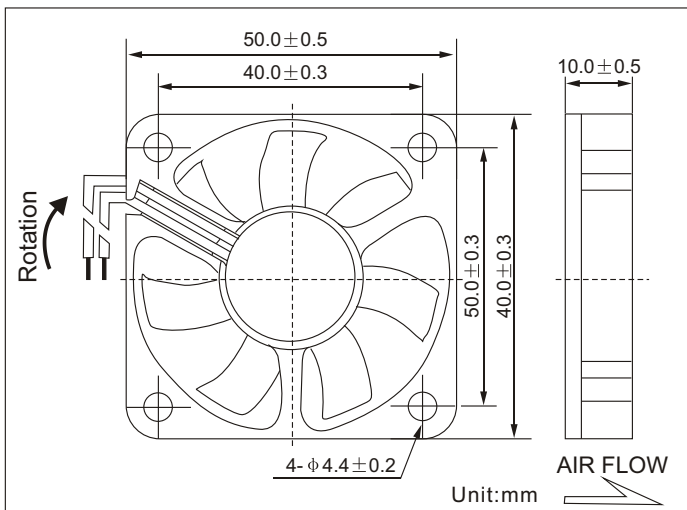

Air Flow vs Air Pressure

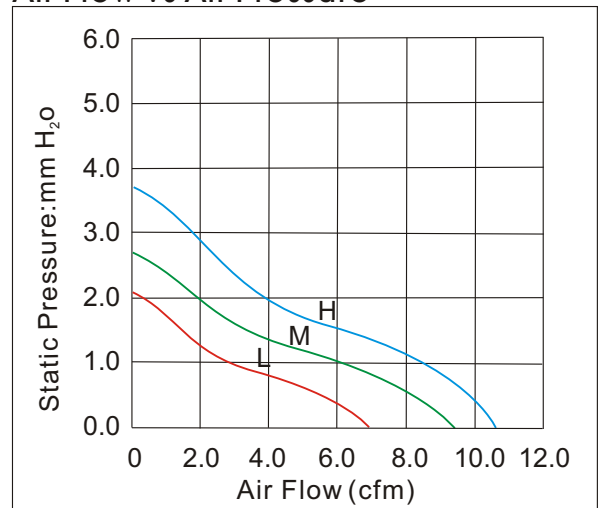

Performance

Model	Bearing System X			Rated Voltage (V)	Current (A)	Input Power (W)	Nominal Speed (R.P.M)	Air Flow (CFM)	Air Pressure (mm-H ₂ O)	Noise (dBA)
	S	B	D							
YD50X05L	✓	✓	✓	5	0.15	0.75	4000	7.20	2.02	21
YD50X05M	✓	✓	✓	5	0.20	1.00	5000	9.15	2.75	27
YD50X05H	✓	✓	✓	5	0.25	1.25	6000	10.20	3.65	33
YD50X12L	✓	✓	✓	12	0.08	0.96	4000	7.20	2.02	21
YD50X12M	✓	✓	✓	12	0.10	1.20	5000	9.15	2.75	27
YD50X12H	✓	✓	✓	12	0.12	1.44	6000	10.20	3.65	33
YD50X24L	✓	✓	✓	24	0.05	1.20	4000	7.20	2.02	21
YD50X24M	✓	✓	✓	24	0.07	1.68	5000	9.15	2.75	27
YD50X24H	✓	✓	✓	24	0.09	2.16	6000	10.20	3.65	33