

# DC Axial Fans



## YD40X05L(M)(H) YD40X12L(M)(H) YD40X24L(M)(H)

### Features

Size: 40×40×10mm(1.57×1.57×0.39in)

Frame/Impeller: Reinforced Plastic UL94V-0

Bearings: Ball Bearing&Sleeve Bearing

Life Expectancy:50,000 Hours at 20°C-Ball

30,000 Hours at 20°C-Sleeve

Approvals: UL CUL TUV CE RoHS

Weight: 18g

  E318377 CE TUV AE50078978

▪ RoHS Compliant

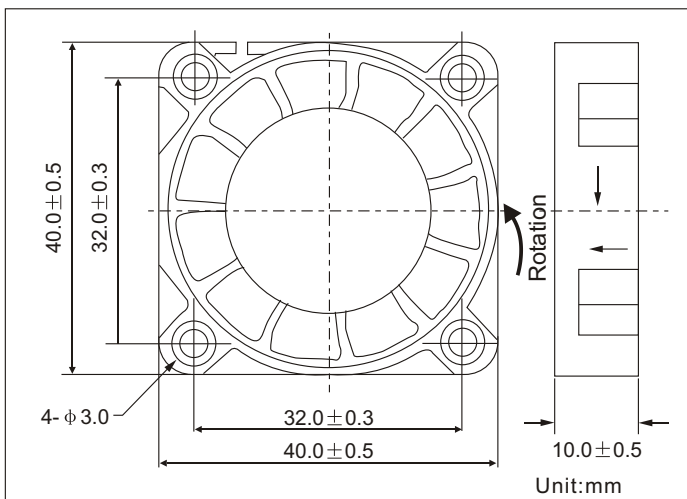

### Air Flow vs Air Pressure

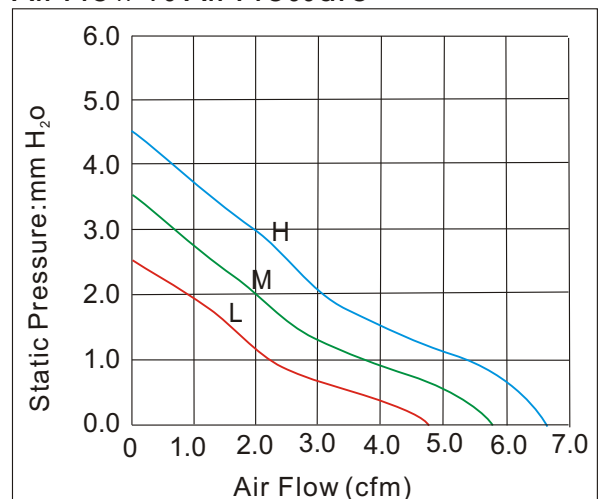

### Performance

Model	Bearing System X			Rated Voltage (V)	Current (A)	Input Power (W)	Nominal Speed (R.P.M)	Air Flow (CFM)	Air Pressure (mm-H <sub>2</sub> O)	Noise (dBA)
	S	B	D							
YD40X05L	✓	✓	✓	5	0.65	0.65	5000	4.85	2.52	20
YD40X05M	✓	✓	✓	5	0.90	0.90	6000	5.75	3.55	24
YD40X05H	✓	✓	✓	5	1.00	1.00	7000	6.66	4.55	28
YD40X12L	✓	✓	✓	12	0.60	0.60	5000	4.85	2.52	20
YD40X12M	✓	✓	✓	12	0.84	0.84	6000	5.75	3.55	24
YD40X12H	✓	✓	✓	12	1.44	1.44	7000	6.66	4.55	28
YD40X24L	✓	✓	✓	24	0.96	0.96	5000	4.85	2.52	20
YD40X24M	✓	✓	✓	24	1.44	1.44	6000	5.75	3.55	24
YD40X24H	✓	✓	✓	24	1.92	1.92	7000	6.66	4.55	28