

DC Axial Fans

YD35X05L(M)(H) YD35X12L(M)(H)

Features

Size: 35×35×10mm(1.38×1.38×0.39in)

Frame/Impeller: Reinforced Plastic UL94V-0

Bearings: Ball Bearing&Sleeve Bearing

Life Expectancy:50,000 Hours at 20°C-Ball

30,000 Hours at 20°C-Sleeve

Approvals: UL CUL TUV CE RoHS

Weight: 10g

  E318377 CE TUV AE50078978

▪ RoHS Compliant

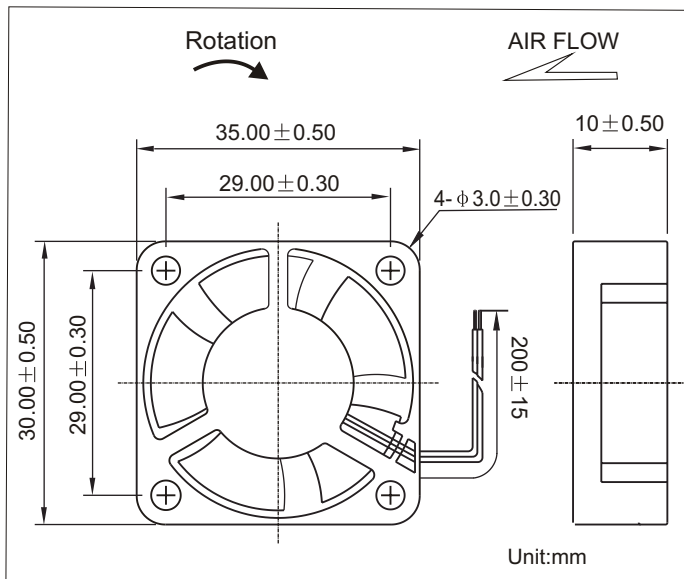

Air Flow vs Air Pressure

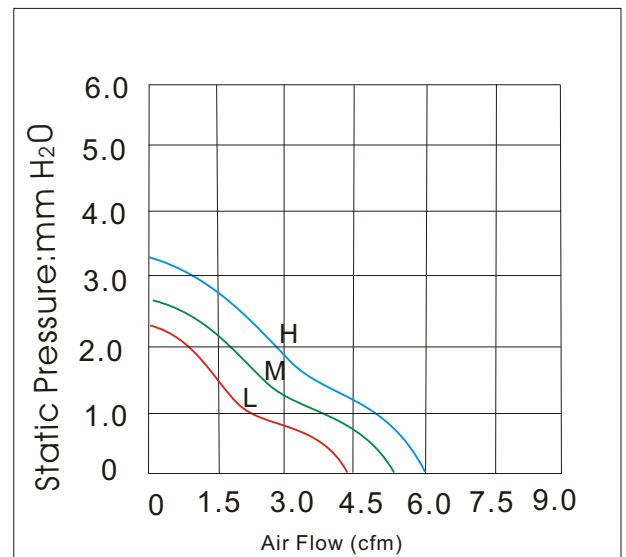

Performance

Model	Bearing System X			Rated Voltage (V)	Current (A)	Input Power (W)	Nominal Speed (R.P.M)	Air Flow (CFM)	Air Pressure (mm-H ₂ O)	Noise (dBA)
	S	B	D							
YD35X05L	✓	✓	✓	5	0.10	0.50	6000	4.40	2.30	16
YD35X05M	✓	✓	✓	5	0.12	0.60	7000	5.10	2.68	18
YD35X05H	✓	✓	✓	5	0.15	0.75	8000	6.00	3.31	20
YD35X12L	✓	✓	✓	12	0.08	0.96	6000	4.40	2.30	16
YD35X12M	✓	✓	✓	12	0.10	1.20	7000	5.10	2.68	18
YD35X12H	✓	✓	✓	12	0.12	1.44	8000	6.00	3.31	20