

DC Axial Fans



YD31X05L(M)(H) YD31X12L(M)(H)

Features

Size: 30×30×10mm(1.18×1.18×0.39in)

Frame/Impeller: Reinforced Plastic UL94V-0

Bearings: Ball Bearing&Sleeve Bearing

Life Expectancy:50,000 Hours at 20°C-Ball

30,000 Hours at 20°C-Sleeve

Approvals: UL CUL TUV CE RoHS

Weight: 6g

  E318377 CE TUV AE50078959

• RoHS Compliant

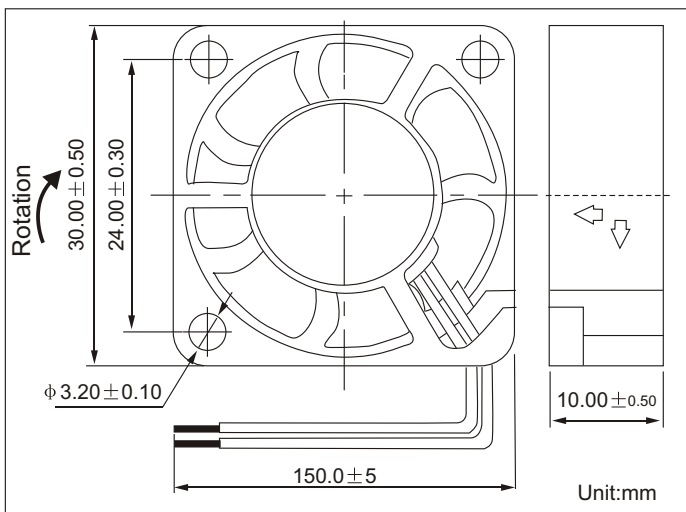

Air Flow vs Air Pressure

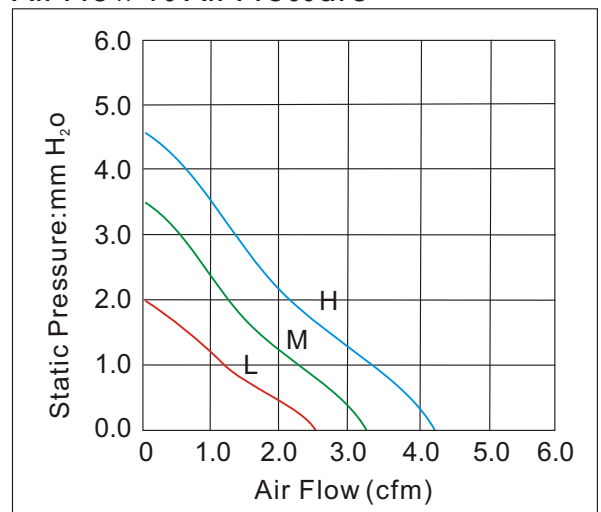

Performance

Model	Bearing System X			Rated Voltage (V)	Current (A)	Input Power (W)	Nominal Speed (R.P.M)	Air Flow (CFM)	Air Pressure (mm-H ₂ O)	Noise (dBA)
	S	B	D							
YD31X05L	✓	✓	✓	5	0.10	0.50	6000	2.46	2.00	18
YD31X05M	✓	✓	✓	5	0.12	0.60	8000	3.27	3.57	23
YD31X05H	✓	✓	✓	5	0.15	0.75	10000	4.10	4.52	29
YD31X12L	✓	✓	✓	12	0.08	0.96	6000	2.46	3.00	18
YD31X12M	✓	✓	✓	12	0.10	1.20	8000	3.27	3.57	23
YD31X12H	✓	✓	✓	12	0.12	1.44	10000	4.10	4.52	29