

DC Axial Fans

YD27X05L(M)(H) YD27X12L(M)(H)

Features

Size: 25×25×07mm(1.0×1.0×0.28in)

Frame/Impeller: Reinforced Plastic UL94V-0

Bearings: Ball Bearing&Sleeve Bearing

Life Expectancy:50,000 Hours at 20°C-Ball
30,000 Hours at 20°C-Sleeve

Approvals: UL CUL TUV CE RoHS

Weight: 6g

  E318377 CE TUV AE50078959

• RoHS Compliant

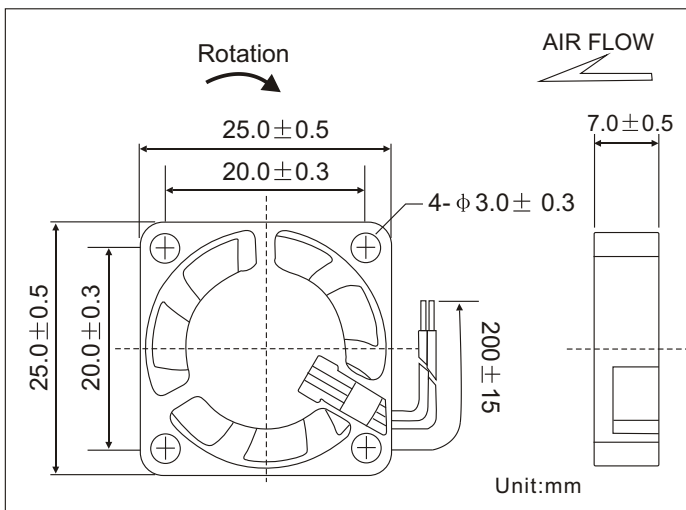

Air Flow vs Air Pressure

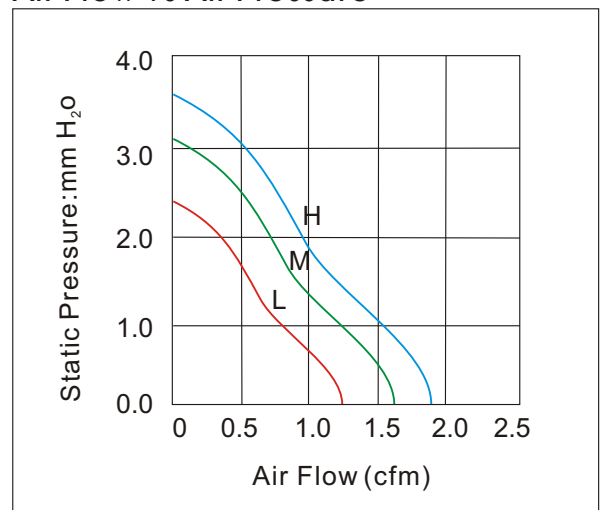

Performance

Model	Bearing System X			Rated Voltage (V)	Current (A)	Input Power (W)	Nominal Speed (R.P.M)	Air Flow (CFM)	Air Pressure (mm-H ₂ O)	Noise (dBA)
	S	B	D							
YD27X05L	✓	✓	✓	5	0.10	0.50	8000	1.25	2.41	16
YD27X05M	✓	✓	✓	5	0.12	0.60	10000	1.55	3.13	18
YD27X05H	✓	✓	✓	5	0.15	0.75	12000	1.80	3.76	20
YD27X12L	✓	✓	✓	12	0.08	0.96	8000	1.25	2.41	16
YD27X12M	✓	✓	✓	12	0.10	1.20	10000	1.55	3.13	18
YD27X12H	✓	✓	✓	12	0.12	1.44	12000	1.80	3.76	20